

DMP 333

Industrial Pressure Transmitter For High Pressure

Stainless Steel Sensor

accuracy according to EN IEC 62828-2:
standard: 0.35 % span
option: 0.25 % span



Nominal pressure

from 0 ... 100 bar up to 0 ... 600 bar

Output signals

2-wire: 4 ... 20 mA

3-wire: 0 ... 20 mA / 0 ... 10 V

others on request

Special characteristics

- ▶ excellent long-term stability, also with high dynamic pressure loads
- ▶ insensitive to pressure peaks
- ▶ high overpressure capability

Optional versions

- ▶ IS-version
Ex ia = intrinsically safe for gases and dusts
- ▶ SIL 2 version
according to IEC 61508 / IEC 61511
- ▶ customer specific versions

The pressure transmitter type DMP 333 has been especially designed for use in hydraulic applications with high static and dynamic pressure. The transmitter is characterized by an excellent long term stability, also under fast changing pressure as well as positive and negative pressure peaks.

The modular concept of the device allows to combine different stainless steel sensors and electronic modules with a variety of electrical and mechanical versions. Thus a diversity of variations is created, meeting almost all requirements in hydraulic applications.

Preferred areas of use are

Plant and Machine Engineering

- machine tools
- hydraulic presses
- injection moulding machine
- handling equipment
- elevated platforms
- test benches



Mobile Hydraulics



DMP 333

Industrial Pressure Transmitter

Technical Data

Input pressure range							
Nominal pressure gauge ¹ / abs.	[bar]	60	100	160	250	400	600
Overpressure	[bar]	210	210	600	1000	1000	1000
Burst pressure ≥	[bar]	420	1000	1000	1250	1250	1800
¹ measurement starts with ambient pressure							
Output signal / Supply							
Standard	2-wire:	4 ... 20 mA / V _S = 12 ... 36 V _{DC}			SIL-version: V _S = 14 ... 28 V _{DC}		
Option IS-protection	2-wire:	4 ... 20 mA / V _S = 12 ... 28 V _{DC}			SIL-version: V _S = 14 ... 28 V _{DC}		
Option Accuracy 0.1 % span	2-wire:	4 ... 20 mA / V _S = 12 ... 36 V _{DC}			3-wire: 0 ... 10 V / V _S = 14 ... 30 V _{DC}		
Options 3-wire	3-wire:	0 ... 20 mA / V _S = 14 ... 30 V _{DC}			0 ... 10 V / V _S = 14 ... 30 V _{DC}		
Performance							
Accuracy ²	standard:	≤ ± 0.35 % span					
	option 1:	≤ ± 0.25 % span					
Permissible load	current 2-wire:	R _{max} = [(V _S - V _S min) / 0.02 A] Ω					
	current 3-wire:	R _{max} = 500 Ω					
	voltage 3-wire:	R _{min} = 10 kΩ					
Influence effects	supply:	0.05 % span / 10 V					
	load:	0.05 % span / kΩ					
Long term stability	≤ ± 0.1 % span / year at reference conditions						
Response time	2-wire:	≤ 10 msec					
	3-wire:	≤ 3 msec					
² accuracy according to EN IEC 62828-2– limit point adjustment (non-linearity, hysteresis, repeatability)							
Thermal effects (Offset and Span)							
Tolerance band	≤ ± 0.75 % span						
in compensated range	0 ... 70 °C						
Permissible temperatures							
Permissible temperatures	medium:	-40 ... 125 °C					
	electronics / environment:	-40 ... 85 °C					
	storage:	-40 ... 100 °C					
Electrical protection							
Short-circuit protection	permanent						
Reverse polarity protection	no damage, but also no function						
Electromagnetic compatibility	emission and immunity according to EN 61326						
Mechanical stability							
Vibration	10 g RMS (25 ... 2000 Hz) according to DIN EN 60068-2-6						
Shock	100 g / 11 msec according to DIN EN 60068-2-27						
Materials							
Pressure port	stainless steel 1.4404 (316 L)						
Housing	stainless steel 1.4404 (316 L)						
Option field housing	stainless steel 1.4301 (304), cable gland M16x 1.5 brass, nickel plated (clamping range 2...8 mm)						
Seals (media wetted)	standard:	FKM					
	options:	EPDM (for P _N ≤ 160 bar)					
		NBR					
		others on request					
Diaphragm	stainless steel 1.4435 (316 L)						
Media wetted parts	pressure port, seals, diaphragm						
Explosion protection (only for 4 ... 20 mA / 2-wire)							
Approvals	IBExU10ATEX1122 X						
DX9-DMP 333	zone 0:	II 1G Ex ia IIC T4 Ga					
	zone 20:	II 1D Ex ia IIIC T135°C Da					
Safety technical maximum values	U _i = 28 V _{DC} , I _i = 93 mA, P _i = 660 mW, C _i ≈ 0 nF, L _i ≈ 0 μH, the supply connections have an inner capacity of max. 27 nF to the housing						
Ambient temperature range	in zone 0:	-20 ... 60 °C with p _{atm} 0.8 bar up to 1.1 bar					
	in zone 1 or higher:	-40/-20 ... 70 °C (lower temperature limit depends on the type of cable used)					
Connecting cables (by factory)	cable capacitance:	signal line/shield also signal line/signal line: 160 pF/m					
	cable inductance:	signal line/shield also signal line/signal line: 1 μH/m					

Miscellaneous	
Option SIL ³ 2	according to IEC 61508 / IEC 61511
Current consumption	signal output current: max. 25 mA signal output voltage: max. 7 mA
Weight	approx. 140 g
Installation position	any ⁴
Operational life	100 million load cycles
CE-conformity	EMC Directive: 2014/30/EU Pressure Equipment Directive: 2014/68/EU (module A) ⁵
ATEX Directive	2014/34/EU

³ only for 4 ... 20 mA / 2-wire, not in combination with the accuracy 0.1%

⁴ Pressure transmitters are calibrated in a vertical position with the pressure connection down.

⁵ This directive is only valid for devices with maximum permissible overpressure > 200 bar

Wiring diagrams

2-wire-system (current)

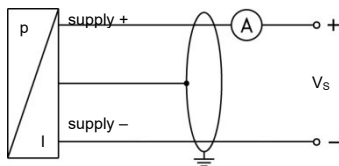

3-wire-system (current / voltage)

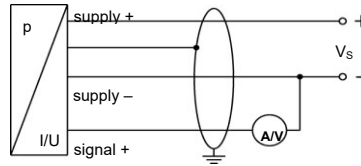

Pin configuration

Electrical connection	ISO 4400	Binder 723 (5-pin)	M12x1 / metal (4-pin)	Bayonet MIL-C-26482 (10-6)	field housing	cable colours (IEC 60757)
Supply +	1	3	1	A	IN +	wh (white)
Supply -	2	4	2	B	IN -	bn (brown)
Signal + (only for 3-wire)	3	1	3	-	OUT +	gn (green)
Shield	ground pin	5	4	pressure port		ye/gn (yellow / green)

Electrical connections (dimensions in mm)

standard

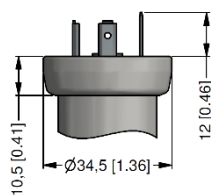

ISO 4400 (IP 65)

option

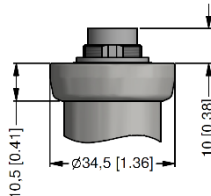

Binder Series 723 5-pin (IP 67)

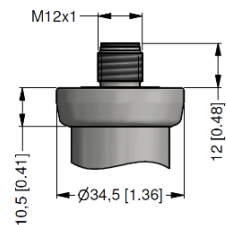

M12x1 4-pin (IP 67)

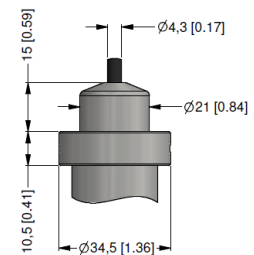

cable gland PG7/cable length specify (IP 67)⁶

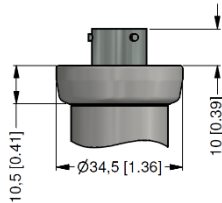

Bayonet MIL-C-26482 (10-6) (IP 67)



field housing (IP 67)

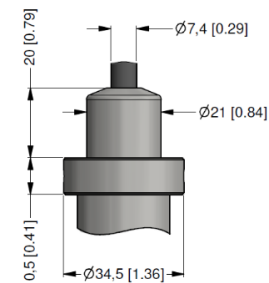

cable outlet with ventilation tube (IP 68)⁷

⇒ universal field housing stainless steel 1.4404 (316 L) with cable gland M20x1.5 (ordering code 880) and other versions on request

⁶ standard: 2 m PVC cable without ventilation tube (permissible temperature: -5 ... 70 °C)

⁷ different cable types and lengths available, permissible temperature depends on kind of cable

Mechanical connections (dimensions in mm)

standard for accuracy 0.35 / 0.5 %

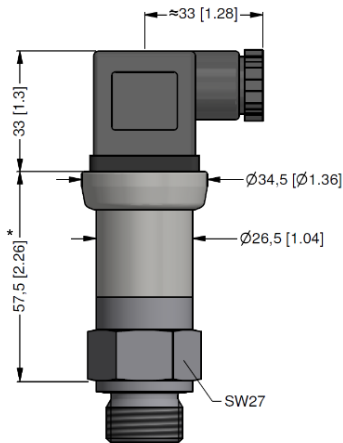

G1/2" DIN 3852
with ISO 4400

standard for accuracy 0.25 %;
SIL- and SIL-IS-version

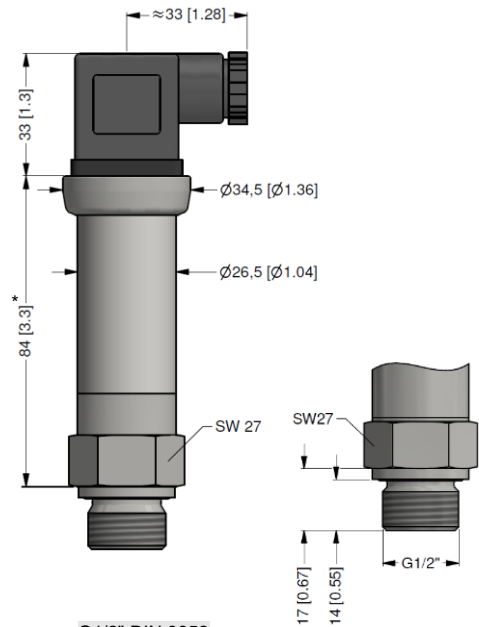

G1/2" DIN 3852
with ISO 4400

option

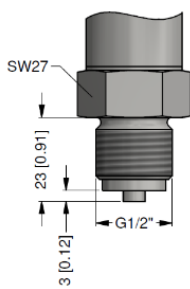

G1/2" EN 837

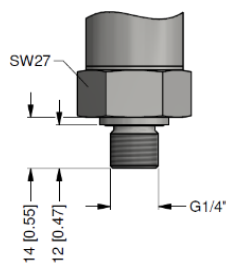

G1/4" DIN 3852

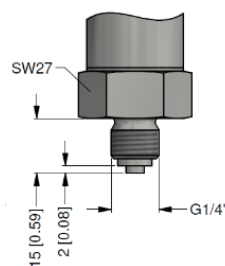

G1/4" EN 837

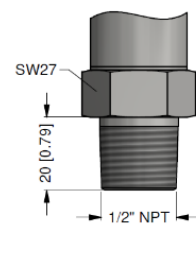

1/2" NPT

⇒ metric threads and other versions on request

* with electrical connection Bayonet MIL-C-26482 (10-6) increases the length of devices by 5 mm.

This data sheet contains product specification. properties are not guaranteed. Subject to change without notice.

0,-...without additional charge
On request... in accordance with the producer

Surcharges for calibration are not subject to any discounts. Subject to change.

This document contains the specification for ordering the product; detailed technical parameters of the product and its possible variants are given in the data sheet.
BD SENSORS reserves the right to change sensor specifications without further notice.

1 measurement starts with ambient pressure

2 not in combination with SIL

3 code TR0 = PVC cable, cable with ventilation tube available in different types and lengths; cable not included in the price



BD SENSORS s.r.o.
Hradištská 817
CZ – 687 08 Buchlovice

Tel.: +420 572 411 011
Fax: +420 572 411 497

www.bdsensors.cz
info@bdsensors.cz

The company BD SENSORS s.r.o. is certified by TÜV SÜD Czech according to the standard ISO 9001.

