

DMP 331

Industrial Pressure Transmitter for Low Pressure

Stainless Steel Sensor

accuracy according to EN IEC 62828-2:
standard: 0.35 % span
option: 0.25 % span



Nominal pressure

from 0 ... 100 mbar up to 0 ... 40 bar

Output signals

2-wire: 4 ... 20 mA

3-wire: 0 ... 20 mA / 0 ... 10 V

others on request

Special characteristic

- ▶ perfect thermal behaviour
- ▶ excellent long term stability
- ▶ pressure port
G 1/2" flush from 100 mbar



Optional versions

- ▶ IS-version
Ex ia = intrinsically safe for gases and dusts
- ▶ SIL 2-according to
IEC 61508 / IEC 61511
- ▶ pressure sensor welded
- ▶ customer specific versions

The pressure transmitter DMP 331 can be used in all industrial areas when the medium is compatible with stainless steel 1.4404 (316 L) or 1.4435 (316 L). Additional are different elastomer seals as well as a helium tested welded version available.

The modulare concept of the device allows to combine different stainless steel sensors and electronic modules with a variety of electrical and mechanical versions. Thus a diversity of variations is created, meeting almost all requirements in industrial applications.

Preferred areas of use are

-  Plant and Machine Engineering
-  Environmental Engineering
(water - sewage - recycling)
-  Energy Industry



Input pressure range									
Nominal pressure gauge	[bar]	-1...0	0.10	0.16	0.25	0.40	0.60	1	1.6
Nominal pressure abs.	[bar]	-	-	-	-	0.40	0.60	1	1.6
Overpressure	[bar]	5	0.5	1	1	2	5	5	10
Burst pressure ≥	[bar]	7.5	1.5	1.5	1.5	3	7.5	7.5	15

Nominal pressure gauge / abs.	[bar]	2.5	4	6	10	16	25	40
Overpressure	[bar]	10	20	40	40	80	80	105
Burst pressure ≥	[bar]	15	25	50	50	120	120	210
Vacuum resistance		P _N ≥ 1 bar: unlimited vacuum resistance P _N < 1 bar: on request						

Output signal / Supply		
Standard	2-wire: 4 ... 20 mA / V _S = 8 ... 32 V _{DC}	SIL-version: V _S = 14 ... 28 V _{DC}
Option IS-protection	2-wire: 4 ... 20 mA / V _S = 10 ... 28 V _{DC}	SIL-version: V _S = 14 ... 28 V _{DC}
Option Accuracy 0.1 % span	2-wire: 4 ... 20 mA / V _S = 12 ... 36 V _{DC}	3-wire: 0 ... 10 V / U _B = 14 ... 30 V _{DC}
Options 3-wire	3-wire: 0 ... 20 mA / V _S = 14 ... 30 V _{DC} 0 ... 10 V / V _S = 14 ... 30 V _{DC}	

Performance	
Accuracy ¹	standard: nominal pressure < 0.4 bar: ≤ ± 0.5 % span nominal pressure ≥ 0.4 bar: ≤ ± 0.35 % span option 1: nominal pressure ≥ 0.4 bar: ≤ ± 0.25 % span
Permissible load	current 2-wire: R _{max} = [(V _S - V _S min) / 0.02 A] Ω current 3-wire: R _{max} = 500 Ω voltage 3-wire: R _{min} = 10 kΩ
Influence effects	supply: 0.05 % span / 10 V load: 0.05 % span / kΩ
Long term stability	≤ ± 0.1 % span / year at reference conditions
Response time	2-wire: ≤ 10 msec 3-wire: ≤ 3 msec

¹ accuracy according to EN IEC 62828-2- limit point adjustment (non-linearity, hysteresis, repeatability)

Thermal effects (Offset and Span)				
Nominal pressure P _N	[bar]	-1 ... 0	< 0.40	≥ 0.40
Tolerance band	[% span]	≤ ± 0.75	≤ ± 1	≤ ± 0.75
in compensated range	[°C]	0 ... 85	0 ... 70	0 ... 85

Permissible temperatures	
Permissible temperatures	medium: -40 ... 125 °C electronics / environment: -40 ... 85 °C storage: -40 ... 100 °C

Electrical protection	
Short-circuit protection	permanent
Reverse polarity protection	no damage, but also no function
Electromagnetic compatibility	emission and immunity according to EN 61326
Integrated overvoltage protection (ground wire) in accordance with CSN EN 61000-4-5 (1 kV)- version with the output signal 4...20 mA / 2-wire	

Mechanical stability	
Vibration	10 g RMS (25 ... 2000 Hz) according to DIN EN 60068-2-6
Shock	500 g / 1 msec according to DIN EN 60068-2-27

Materials	
Pressure port	stainless steel 1.4404 (316 L)
Housing	stainless steel 1.4404 (316 L)
Option field housing	stainless steel 1.4301 (304), cable gland M16x1.5, brass, nickel plated (clamping range 2...8 mm)
Seals (media wetted)	standard: FKM options: EPDM NBR welded version ² (for PN ≤ 40 bar) others on request
Diaphragm	stainless steel 1.4435 (316 L)
Media wetted parts	pressure port, seals, diaphragm

² welded version only with pressure ports according to EN 837

Explosion protection (only for 4 ... 20 mA / 2-wire)	
Approvals	IBExU10ATEX1122 X
DX9-DMP 331	zone 0: II 1G Ex ia IIC T4 Ga zone 20: II 1D Ex ia IIIC T135°C Da
Safety technical maximum values	U _i = 28 V, I _i = 93 mA, P _i = 660 mW, C _i ≈ 0 nF, L _i ≈ 0 μH, the supply connections have an inner capacity of max. 27 nF to the housing
Ambient temperature range	in zone 0: -20 ... 60 °C with p _{atm} 0.8 bar up to 1.1 bar in zone 1 or higher: -40/-20 ... 70 °C (lower temperature limit depends on the type of cable used)
Connecting cables (by factory)	cable capacitance: signal line/shield also signal line/signal line: 160 pF/m cable inductance: signal line/shield also signal line/signal line: 1μH/m

Miscellaneous			
Option SIL ³ 2	according to IEC 61508 / IEC 61511		
Current consumption	signal output current: max. 25 mA	signal output voltage: max. 7 mA	
Weight	approx. 200 g		
Installation position	any ⁴		
Operational life	100 million load cycles		
CE-conformity	EMC Directive: 2014/30/EU		
ATEX Directive	2014/34/EU		

³ only for 4 ... 20 mA / 2-wire, not in combination with the accuracy 0.1%

⁴ Pressure transmitters are calibrated in a vertical position with the pressure connection down. If this position is changed on installation there can be slight deviations in the zero point for pressure ranges $P_N \leq 1$ bar.

Wiring diagrams

2-wire-system (current)

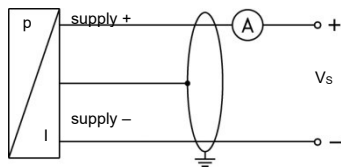

3-wire-system (current / voltage)

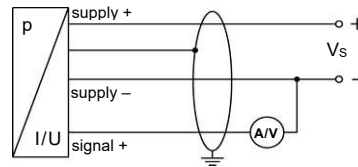

Pin configuration

Electrical connection	ISO 4400	Binder 723 (5-pin)	M12x1 / metal (4-pin)	Bayonet MIL-C-26482 (10-6)		field housing	cable colours (DIN 47100)
				2-wire	3-wire		
Supply +	1	3	1	A	A	IN + IN - OUT+	wh (white) bn (brown) gn (green)
Supply -	2	4	2	B	D		
Signal + (for 3-wire)	3	1	3	-	B		
Shield	ground pin	5	4	pressure port			gn/ye (green / yellow)

Electrical connections (dimensions in mm)

standard

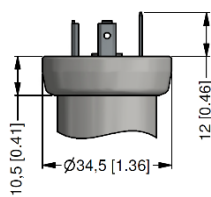

ISO 4400 (IP 65)

option

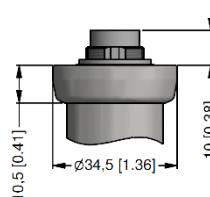

Binder Series 723 5-pin (IP 67)

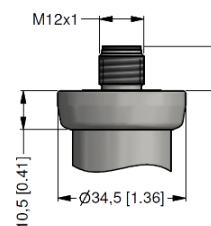

M12x1 4-pin (IP 67)

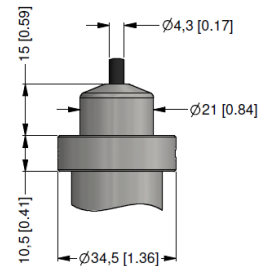

cable gland PG7 / cable length specify (IP 67)⁵

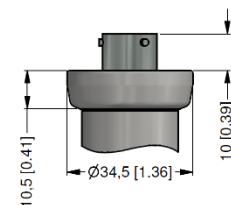

Bayonet MIL-C-26482 (10-6) (IP 67)

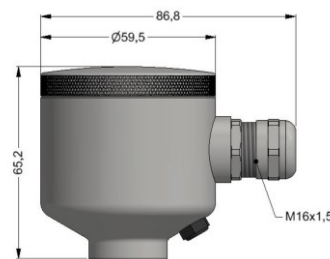

field housing (IP 67)

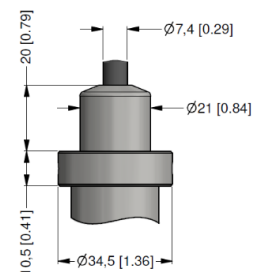

cable outlet, cable with ventilation tube (IP 68)⁶

⇒ universal field housing stainless steel 1.4404 (316 L) with cable gland M20x1.5 (ordering code 880) and other versions on request

⁵ standard: 2 m PVC cable without ventilation tube (permissible temperature: -5 ... 70°C)

⁶ different cable types and lengths available, permissible temperature depends on kind of cable

Mechanical connections (dimensions in mm)

standard for accuracy 0.5 % / 0.35 / 0.25 %

standard for accuracy
0.25 % with calibration list;
SIL- and SIL-IS-version

*with electrical connection Bayonet MIL-C-26482 (10-6) increases the length of devices by 5 mm

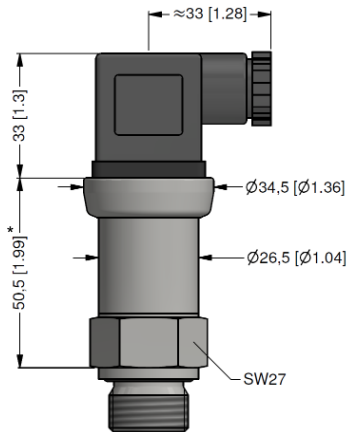

G1/2" DIN 3852
with ISO 4400

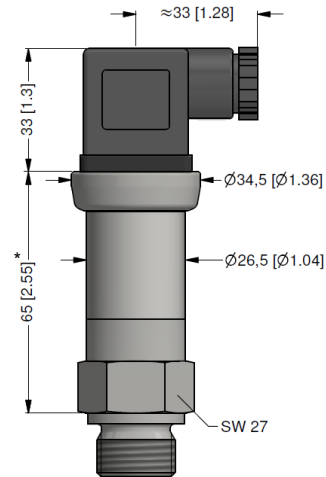

G1/2" DIN 3852
with ISO 4400

option

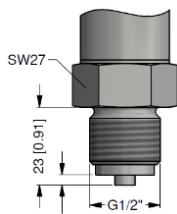

G1/2" EN 837

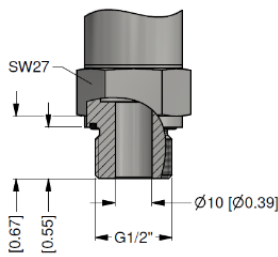

G1/2" open port

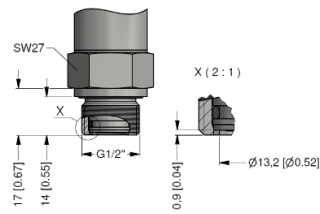

G1/2" DIN 3852
with flush sensor

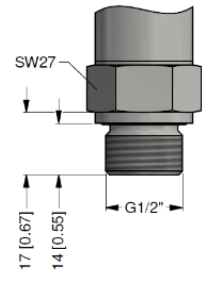

G1/2" DIN 3852

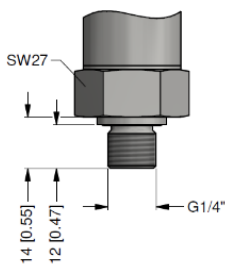

G1/4" DIN 3852

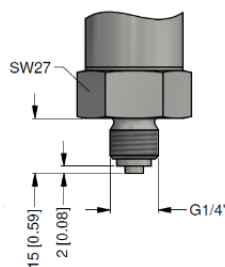

G1/4" EN 837

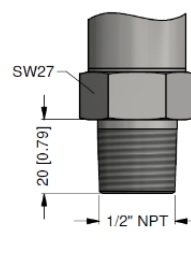

1/2" NPT

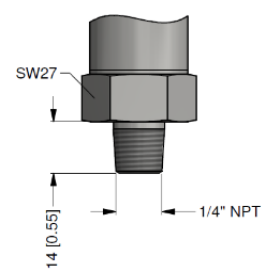

1/4" NPT

⇒ metric threads and other versions on request

This data sheet contains product specification. Properties are not guaranteed. Subject to change without notice.

Ordering code DMP 331

05.06.2024

DMP 331

--	--	--	--	--	--	--	--	--	--	--	--	--	--	--	--	--	--	--	--

Pressure																																							
Gauge																				1	1	0																	
Absolute (possible from 0.4 bar)																				1	1	1																	
Input [bar]																																							
0 ... 0,1 (absolute pressure possible from 0.4 bar)																				1	0	0																	
0 ... 0,16 (absolute pressure possible from 0.4 bar)																				1	6	0																	
0 ... 0,25 (absolute pressure possible from 0.4 bar)																				2	5	0																	
0 ... 0,4																				4	0	0																	
0 ... 0,6																				6	0	0																	
0 ... 1																				1	0	0																	
0 ... 1,6																				1	6	0																	
0 ... 2,5																				2	5	0																	
0 ... 4																				4	0	0																	
0 ... 6																				6	0	0																	
0 ... 10																				1	0	0																	
0 ... 16																				1	6	0																	
0 ... 25																				2	5	0																	
0 ... 40																				4	0	0																	
-1 ... 0																				X	1	0																	
Customer																				9	9	9																	
Customer - underpressure																				X	X	X																	
Customer (0,5 ≤ P _N < 1 bar)																				9	9	9																	
Customer (0,25 ≤ P _N < 0,5 bar)																				9	9	9																	
Customer (0,1 ≤ P _N < 0,25 bar)																				9	9	9																	
Underpressure (0,5 ≤ P _N < 1 bar)																				X	X	X																	
Underpressure (0,25 ≤ P _N < 0,5 bar)																				X	X	X																	
Underpressure (0,1 ≤ P _N < 0,25 bar)																				X	X	X																	
Output																																							
4 ... 20 mA / 2-wire																				1																			
0 ... 20 mA / 3-wire																				2																			
0 ... 10 V / 3-wire																				3																			
0...5 V / 3-wire																				4																			
0...1 V / 3-wire																				5																			
1...6 V / 3-wire																				6																			
4...20 mA / 3-wire																				7																			
10 ... 90% of V _s / 3-wire ratiometric (V _s = 2,7 ... 5 V DC)																				R																			
Intrinsic safety 4...20 mA / 2-wire (only for acc. ≥ 0,25 %)																				E																			
Ex ec 4 ... 20 mA / 2-wire (connector 105, acc. ≥ 0,25 %)																				NE																			
SIL2, 4 ... 20 mA / 2-wire (only for acc. ≥ 0,25 %)																				1S																			
SIL2, Intrinsic safety 4...20 mA / 2-wire (only for acc. ≥ 0,25 %)																				ES																			
Customer																				9																			
Accuracy																																							
0,5 %																				5																			
0,35 % (P _N ≥ 0,4 bar)																				3																			
0,25 % (P _N ≥ 0,4 bar)																				2																			
0,2 % (only range P _n ≥ 1 bar 4...20 mA / 2-wire + connector 100 + version 090)																				B																			
0,5 % including Calibration Certificate																				T																			
0,35 % including Calibration Certificate (P _N ≥ 0,4 bar)																				S																			
0,25 % including Calibration Certificate (P _N ≥ 0,4 bar)																				R																			
Table of measured values for accuracy 0,5 %																				N																			
Table of measured values for accuracy 0,35 %																				M																			
Customer																				9																			
Electrical connection																																							
Connector DIN 43650 (ISO 4400) (IP 65)																				1	0	0																	
Connector ISO 4400 (IP 65) + silicone seals (for Ex ec)																				1	0	5																	
Connector Binder 723 5-pin (IP 67)																				2	0	0																	
Cable gland PG7 / cable length specify (IP 67)																				4	0	0																	
+ PVC cable / 1 m																																							
Connector Buccaneer (IP 68)																				5	0	0																	
Field housing stainless steel, cable gland M 16 x 1,5 (IP 67)																				8	0	0																	
Field housing stainless steel, cable gland M 20 x 1,5 (IP 67)																				8	8	0																	
Connector DIN 43650 (ISO 4400) - potting compound inside (IP 67)																				E	0	0																	



BD SENSORS s.r.o.
Hradištská 817
CZ – 687 08 Buchlovice

Tel.: +420 572 411 011
Fax: +420 572 411 497

www.bdsensors.cz
info@bdsensors.cz



The company BD SENSORS s.r.o. is certified by TÜV SÜD Czech according to the standard ISO 9001.

Connector M12 x 1, 4-pin (IP 67)	M	0	0							
Connector M12 x 1, 4-pin (IP 67) - metal	M	1	0							
Cable outlet, cable with ventilation tube (IP 68) ¹	T	R	0							
+ PVC cable / 1 m										
Customer	9	9	9							
Mechanical connection										
G 1/2" DIN 3852				1	0	0				
G 1/2" EN 837				2	0	0				
G 1/4" DIN 3852				3	0	0				
G 1/4" EN 837				4	0	0				
M 20 x 1,5 DIN 3852				5	0	0				
M 12 x 1 DIN 3852				6	0	0				
M 10 x 1 DIN 3852				7	0	0				
M 20 x 1,5 EN 837				8	0	0				
M 12 x 1,5 DIN 3852				C	0	0				
G 1/2" DIN 3852 with flush sensor diaphragm ²				F	0	0				
M 20 x 1,5 DIN 3852 with flush sensor diaphragm				F	0	4				
G 1/2" DIN 3852 with flush sensor diaphragm - welded (only with FFKM seal)				G	0	0				
G 1/2" open port (port ø 10 mm) ²				H	0	0				
1/2" NPT				N	0	0				
1/4" NPT				N	4	0				
G 1/8" DIN 3852				Z	3	7				
Customer	9	9	9							
Seals										
Viton (FKM)							1			
Viton (FKM) up to -40 °C (for special version 022)							F			
Without seals - welded (only with EN 837) ^{2,3}							2			
EPDM (drinking water)							3			
FFKM							7			
Customer							9			
Special version										
Standard								0	0	0
Temperature compensation -20...+50 °C								0	0	6
Temperature compensation -40...+60 °C (only with seals "F" or welded "2")								0	2	2
Reduced supply voltage 7...30 V DC only for 4...20 mA / 2-wire								0	2	A
Adjustable (using trimmers) - ATTENTION must not be used in an EX environment								0	4	1
Customer								0	9	0
								9	9	9

0,-...without additional charge

On request... in accordance with the producer

This document contains the specification for ordering the product; detailed technical parameters of the product and its possible variants are given in the data sheet.

BD SENSORS reserves the right to change sensor specifications without further notice.

Surcharges for calibration are not subject to any discount.

1 code TR0 = PVC cable, cable with ventilation tube available in different types and lengths; cable not included in the price

2 only for P_N ≤ 40 bar

3 welded version only with pressure ports according to EN 837



BD SENSORS s.r.o.
Hradištská 817
CZ – 687 08 Buchlovice

Tel.: +420 572 411 011
Fax: +420 572 411 497

www.bdsensors.cz
info@bdsensors.cz

The company BD SENSORS s.r.o. is certified by TÜV SÜD Czech according to the standard ISO 9001.

