

# DLM-35

# Dinel<sup>®</sup>

## CAPACITIVE LEVEL METER

For continuous level measurement of liquids, bulk solids and powders in tanks, hoppers etc.



MIN  
-40°C



nastavení  
magnetickým perem

- For continuous level measurement of liquids or bulk solids
- Wide spectrum of use, direct mounting into tanks, vessels, sumps or silos and hoppers
- Setting using a magnetic pen without the need for complete emptying of the tank
- Possibility of linear measurement even in nonconductive or variously shaped vessels
- Optical indication of function and status of level meter by two LEDs
- Wide selection of electrical connection: connector or cable glands
- Housing, electrodes and reference tubes made from stainless steel
- Variants with coated electrode for aggressive or electrically conductive media

### TECHNICAL SPECIFICATION

Supply voltage	variant „I“ variant „U“	9 ... 34 V DC 12 ... 34 V DC
Output type	variant „I“ variant „U“	4 ... 20 mA (2-wire) 0 ... 10 V (3-wire)
Non-linearity		max. 1 %
Ambient working temperatures		-40 ... +85 °C
Working temperatures at process connection		-40 ... +200 °C
Medium temperatures		-40 ... +300 °C
Process connection		thread M27 x 2 ; M30 x 1,5 ; G1, G 3/4";NPT3/4; TriClamp ø34, ø50,5
Pressure range at process connection (at +85 °C)	DLM-35_-20, 30 DLM-35_-21, 22, 25, 31, 40, 41 DLM-35_-50	0 ... 25 bar 0 ... 20 bar 0 ... 1 bar
Protection	DLM-35_-_-_-C_-_- DLM-35_-_-_-A(B,D,V,H)-_-_-	IP67 IP68

# BASIC FEATURES AND VARIANTS

The capacitive level meters DLM® are intended for continuous level measurement of liquid and bulk solids in tanks, vessels, sumps or silos, hoppers etc. They are comprised of a housing with electronic module and measuring electrodes. The electronic part converts the size of the capacity to the current signal (4 ... 20 mA) or voltage signal (0 ... 10 V). Level meters are made in several modifications of measuring electrodes (rod and rope). The electrodes can be covered by an insulating coating in case level measurement of adhesive, aggressive or electrically conductive media. Rod electrodes are also available in a version with reference (coaxial) tube for level measurement of liquids in tanks made from non-conductive material

Level meters are produced in the following performances: N - for non-explosive areas, NT - high temperature for non-explosive areas, Xi - Explosion proof - intrinsically safe for hazardous (explosive) areas and XiM - Explosion proof - intrinsically safe for use in mines with methane or flammable dust presence danger (see technical specifications). There are high temperature performance NT, XiT, XiMT available. DLM are offered in variants with various types of process connection (metric and pipe thread, pressure thread NPT).

## VARIANTS

code	electrode type	electrode length
DLM-35_-20	<b>Uncoated rod electrode</b> for level measurement of bulk-solids and electrically non-conductive liquids	0,1 ... 2 m
DLM-35_-21	<b>Coated rod electrode (insulation FEP)</b> for level measurement of water and other electrically conductive liquids. Can also be used for polluted liquids in metal tanks, concrete sumps, etc.	0,1 ... 2 m
DLM-35_-22	<b>Coated rod electrode (insulation PFA)</b> with enhanced resistance to permeation (diffusion) of vapours and gases. For level measurement of water and other electric conductive liquids in the food, pharmaceutical and chemical industries	0,1 ... 2 m
DLM-35_-25	<b>new design</b> , like DLM-35_-21 but higher pressure resistance at high temperature. Suitable for high temperature applications (hot steam)	0,1 ... 2 m
DLM-35_-30	<b>Coated rope electrode with weight (FEP)</b> , for electrically conductive and non-conductive liquids.	0,1 ... 3 m
DLM-35_-31	<b>Coated rod electrode (FEP)</b> for level measurement of water and other electrically conductive liquids. Can also be used for polluted liquids	0,1 ... 3 m
DLM-35_-40	<b>Uncoated rod electrode with reference tube</b> (coaxial electrode) for accurate level measurement of unpolluted electrically non-conductive liquids	0,1 ... 1 m
DLM-35_-41	<b>Coated rod electrode with reference tube (coaxial electrode)</b> for accurate level measurement of unpolluted electrically conductive liquids in plastic and glass tanks.	0,1 ... 1 m
DLM-35_-50	<b>Uncoated rope electrode with weight</b> for level measurement of bulk-solids	0,5 ... 6 m
DLM-35_-52	<b>Coated rope electrode with weight (FEP)</b> , for electrically conductive and non-conductive liquids	1 ... 10 m

## DIMENSIONS

DLM - 35\_- 20

DLM - 35\_- 21, 22

DLM - 35\_- 25

DLM - 35\_- 30

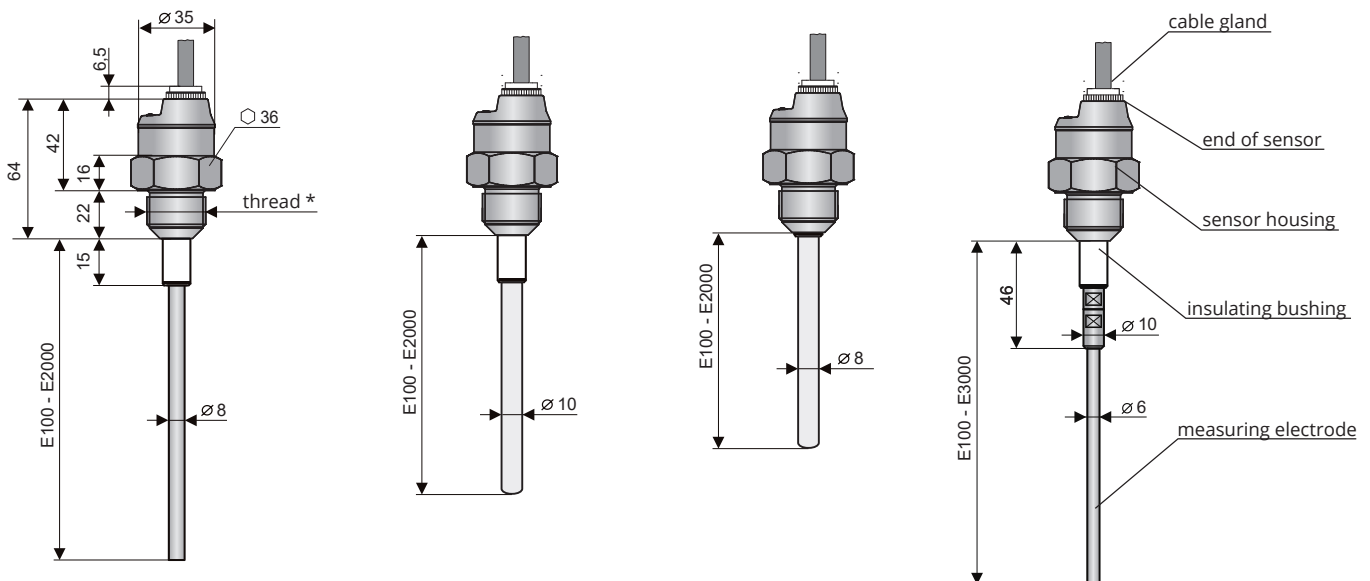

DLM-35\_31

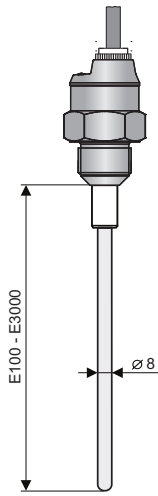

DLM-35\_50

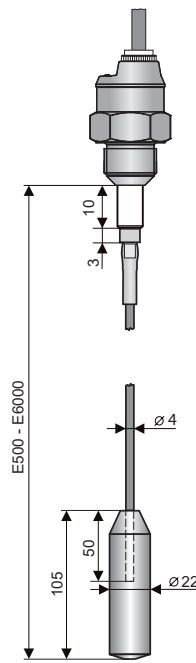

DLM-35\_52

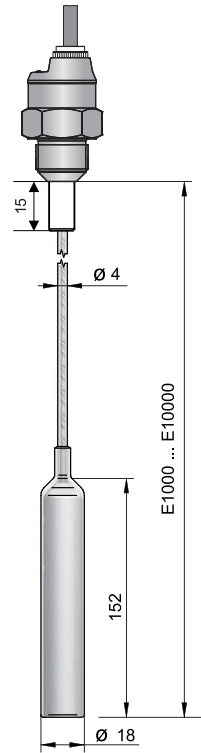

Process connection  
Tri-clamp

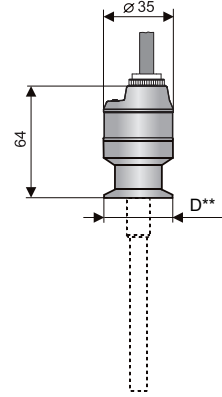

\* type of thread: G 1"; G 3/4"; M27x2;  
M30x1,5; NPT 3/4  
D\*\* : Tri-Clamp CI34 (ø 34 mm)  
Tri-Clamp CI50 (ø 50,5 mm)

DLM-35\_40

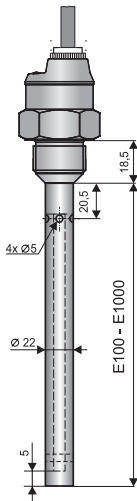

DLM-35\_41



High temperatures  
variants

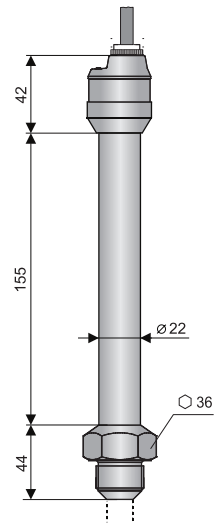

Variant "A" with short  
stainless steel gland

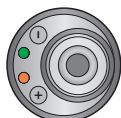
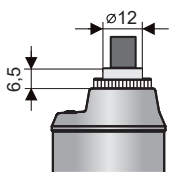

Variant "B" with plastic  
threaded cable gland

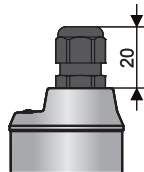

Variant "C" with connector M12

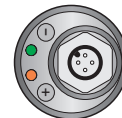
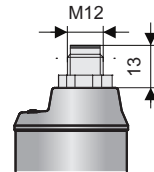

**Variant "D" with dustproof cable outlet**

**Variant "V" with plastic cable gland with spiral relief**  
for case of increased mechanical wear on the cable.

**Variant "H" with cable gland for protected hoses**  
for using in an outdoor area or in area with increased moisture.

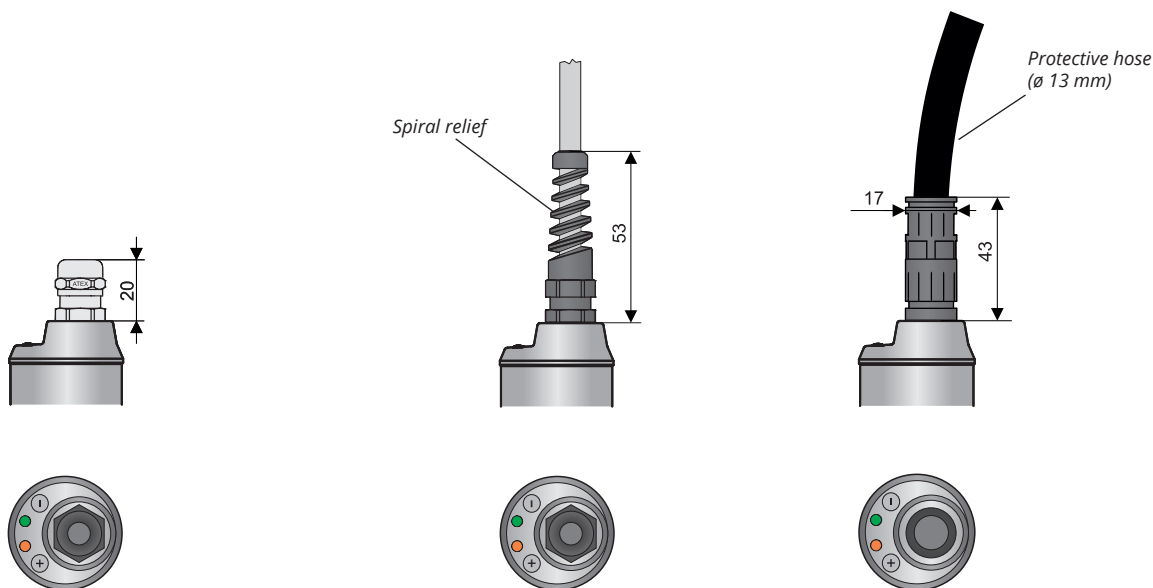

All dimensions are in mm

## TECHNICAL SPECIFICATIONS

### BASIC TECHNICAL DATA

Supply voltage	DLM - 35N(T)-_-_-I DLM - 35N(T)-_-_-U	9 ... 34 V DC 12 ... 34 V DC
Current output		4 ... 20 mA (2-wire)
Voltage output		0 ... 10 V (3-wire)
Power consumption	DLM-35_-_-_-I DLM-35_-_-_-U	3,75 ... 20,5 mA 5 mA (voltage output open circuit)
Non-linearity		max. 1 %
Temperature error		max. 0,05 %/K
Voltage error for current and voltage output		max. 0,3 $\mu$ A/V a 0,1 mV/V
Leakage resistance (electrode - housing) / dielectric strength		1 M $\Omega$ /200 V DC
Coupling capacity (housing - power) / dielectric strength		50 nF/350 V AC
Coupling capacity (electrode - power) / dielectric strength		47 nF/350 V AC
Ambient temperature range:		- 40 ... + 85 °C
Protection	DLM-35_-_-_-C-_-_- DLM-35_-_-_-A(B,D,V,H)-_-_-	IP67 IP68
Maximum load resistance for current output (při U = 24 V)		R <sub>max</sub> = 700 $\Omega$
Hmotnost (bez elektrody)		cca 0,3 kg cca 0,6 kg
Cable (version with cable glands)		PVC 3 x 0,5 mm <sup>2</sup> (version N) or 2 x 0,75 mm <sup>2</sup> (version Xi)

### ELETRICAL PARAMETERS (variant Xi, XiT, XiM, XiMT)

Power supply voltage	9 ... 30 V DC
Limit values	U <sub>i</sub> = 30 V DC; I <sub>i</sub> = 132 mA; P <sub>i</sub> = 0,99 W; C <sub>i</sub> = 35 nF; L <sub>i</sub> = 10 $\mu$ H
Reference value LC for the parameters of the used cable	typic C < 150 pF/m typic L < 0,8 $\mu$ H/m

<b>MATERIALS USED</b>		
<b>sensor</b>	<b>variant</b>	<b>standard material *</b>
<b>Wetted parts</b>		
Housing	all types except Tri-Clamp variant Tri-Clamp	stainless steel W.Nr. 1.4301 (AISI 304) stainless steel W.Nr. 1.4404 (AISI 316L)
Rod electrode	all types except DLM - 35_ - 20, 30, 40	stainless steel W.Nr. 1.4404 (AISI 316L)
Rope electrode	DLM - 35_ - 50	stainless steel W.Nr. 1.4401 (AISI 316)
Reference tube	DLM - 35_ - 40, 41	stainless steel W.Nr. 1.4301 (AISI 304)
Insulating bushing	DLM - 35_ - 20, 21, 22, 30, 31, 40, 41, 52 DLM - 35_ - 50	PTFE PPS + GF40
Electrode coating	DLM - 35_ - 21, 25, 31, 41, 52 DLM - 35_ - 22	FEP PFA
Weight	DLM - 35_ - 50	stainless steel W.Nr. 1.4301 (AISI 304)
<b>Non-wetted parts</b>		
Rod electrode	DLM-35_-21, 22, 25, 31, 41	stainless steel (W.Nr. 1.4404 (AISI 316L))
Weighted rope electrode	DLM-35_-52	stainless steel (W.Nr. 1.4301 (AISI 304L))
Cable gland	DLM - 35_ _ _ -A	stainless steel W.Nr. 1.4571 (AISI 316 Ti)/NBR
	DLM - 35_ _ _ -B	plastic PA / NBR
	DLM - 35_ _ _ -D	nickel-plated brass / PA / rubber CR / NBR
	DLM - 35_ _ _ -V	plastic PA / NBR
	DLM - 35_ _ _ -H	plastic PA / NBR
Connector M12	DLM - 35_ _ _ -C	nickel-plated brass / PA
Ending	all types	stainless steel W.Nr. 1.4301 (AISI 304)

\* It is always necessary to verify the chemical compatibility of the material with the measured medium. You can also choose another type of material after agreement.

<b>PROCESS CONNECTION</b>		
<b>type</b>	<b>size</b>	<b>marking</b>
Pipe thread	G 1"	G1
	G 3/4"	G3/4
Metric thread	M27 x 2	M27
	M30 x 1,5	M30
Taper pipe thread	NPT 3/4	NPT
Jointless connection (Tri-Clamp)	ø 34 mm	CI34
	ø 50,5 mm	CI50

# WORKING AREAS AND AREA CLASSIFICATION EN IEC 60079-0, EN 60079-11, EN 60079-10-1, EN 60079-10-2

DLM - 35N	Basic performance for non-explosive atmospheres.
DLM - 35NT	High-temperature basic performance for non-explosive atmospheres.
DLM - 35Xi (20, 30, 40, 50)	Intrinsically safe explosion-proof performance for use in hazardous areas (explosive gas atmospheres or explosive atmospheres with dust) Ⓢ II 1G Ex ia IIB T4...T2 Ga; Ⓢ II 1D Ex ia IIIC T <sub>200</sub> 120 °C...T <sub>200</sub> 345 °C Da with intrinsically safe supply units, whole sensor zone 0 and 20.
DLM - 35Xi (21, 22, 25, 31, 41, 52)	Intrinsically safe explosion-proof performance for use in hazardous areas (explosive gas atmospheres) Ⓢ II 1G Ex ia IIB T4...T2 Ga; with intrinsically safe supply units, whole sensor zone 0.
DLM - 35XiT (20, 30, 40, 50)	Intrinsically safe high-temperature explosion-proof performance for use in hazardous areas (explosive gas atmospheres or explosive atmospheres with dust) Ⓢ II 1/2G Ex ia IIB T4...T2 Ga/Gb; Ⓢ II 1/2D Ex ia IIIC T <sub>200</sub> 120 °C ... T <sub>200</sub> 345 °C / T 90 °C ... T 315 °C Da/Db with intrinsically safe supply units, electrode part zone 0 and 20, head zone 1 and 21.
DLM - 35XiT (21, 22, 25, 31, 41, 52)	Intrinsically safe high-temperature explosion-proof performance for use in hazardous areas (explosive gas atmospheres) Ⓢ II 1/2G Ex ia IIB T4...T2 Ga/Gb; with intrinsically safe supply units, electrode part zone 0, head zone 1.
DLM - 35XiM	Intrinsically safe explosion-proof performance for use in mines with the occurrence of methane or coal dust Ⓢ I M1 Ex ia I Ma with intrinsically safe supply units.
DLM - 35XiMT	Intrinsically safe high-temperature explosion-proof performance for use in mines with the occurrence of methane or coal dust Ⓢ I M1 Ex ia I Ma with intrinsically safe supply units.

A device or part of it designed for zone 0 can also be used in zone 1 or 2.  
 The device or its part intended for zone 1 can also be used in zone 2  
 The device or its part intended for zone 20 can also be used in zone 21 or 22.  
 The device or its part intended for zone 21 can also be used in zone 22.

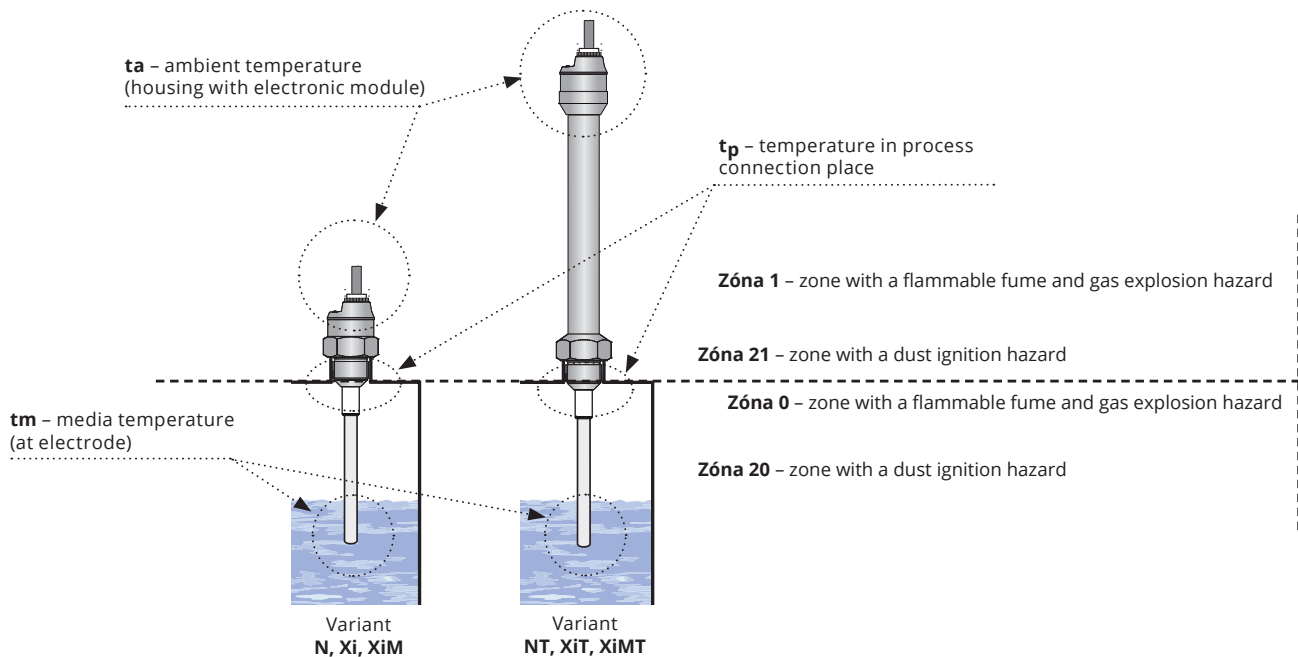

Fig. 18: Illustration of areas for temperature measurement and explosive zones

MAXIMAL MEDIUM TEMPERATURE	
VARIANT Xi(XiT) CATEGORY 1G, 1/2G	
temperature class	temperature tm
T4	+115 °C
T3	+180 °C
T2	+270 °C

MAXIMAL MEDIUM TEMPERATURE	
VARIANT XiM(XiMT) CATEGORY M1	
maximal medium temperature	+ 135 °C

MAXIMAL SURFACE TEMPERATURE	
VARIANT Xi(XiT) KATEGORIE 1D, 1/2D	
process connection place	T <sub>200</sub> =Tm + 45 °C (verze Xi) T=Tm + 15 °C (verze XiT)
process connection	T <sub>200</sub> =Tm + 45 °C (verze Xi) T=Tm + 15 °C (verze XiT)
electrode	T <sub>200</sub> =Tm + 45 °C

## TEMPERATURE RESISTIVITY (variant N, NT, Xi, XiM, XiT, XiMT)

variant	temperature tm	temperature tp	temperature ta
DLM-35N-20, 30	-40 °C ... +300 °C	-40 °C ... +85 °C	-40 °C ... +85 °C
DLM-35N-21, 22, 25, 31, 40, 41, 52	-40 °C ... +200 °C	-40 °C ... +85 °C	-40 °C ... +85 °C
DLM-35N-50	-40 °C ... +250 °C	-40 °C ... +85 °C	-40 °C ... +85 °C
DLM-35NT-20, 30,	-40 °C ... +300 °C	-40 °C ... +200 °C	-40 °C ... +85 °C
DLM-35NT-21, 22, 25, 31, 40, 41, 52	-40 °C ... +200 °C	-40 °C ... +200 °C	-40 °C ... +85 °C
DLM-35NT-50	-40 °C ... +250 °C	-40 °C ... +200 °C	-40 °C ... +85 °C
DLM-35Xi, XiM-20, 30	-40 °C ... +300 °C	-40 °C ... +75 °C	-40 °C ... +75 °C
DLM-35Xi, XiM-21, 22, 25, 31, 40, 41, 52	-40 °C ... +200 °C	-40 °C ... +75 °C	-40 °C ... +75 °C
DLM-35Xi, XiM-50	-40 °C ... +250 °C	-40 °C ... +75 °C	-40 °C ... +75 °C
DLM-35XiT, XiMT-20, 30	-40 °C ... +300 °C	-40 °C ... +200 °C	-40 °C ... +75 °C
DLM-35XiT, XiMT-21, 22, 25, 31, 40, 41, 52	-40 °C ... +200 °C	-40 °C ... +200 °C	-40 °C ... +75 °C
DLM-35XiT, XiMT-50	-40 °C ... +250 °C	-40 °C ... +200 °C	-40 °C ... +75 °C
DLM-35XiM, XiMT - důlní prostředí Ma	max. 150 °C on any surface where the coal-dust can form layers		

Note: For the correct operation of the level sensor, none of the here provided temperature ranges may be exceeded (tp, tm or ta).

The here-mentioned temperatures are visually explain in Fig.

## TABLE OF DEFAULT SETTINGS

4 mA (0 V)	capacitance of the electrode system in free space
20 mA (10 V)	capacity 1 nF (± 20 %)



This setting cannot be used directly for level measurement, but it is always necessary to make the settings according to chapter 9. In special cases (e.g. when using a reference electrode), the sensor settings can be agreed with the manufacturer.

## PRESSURE RESISIVITY (variant N, NT, Xi, XiM, XiT, XiMT)

variant	max. operating pressure for temperature tp				
	Up to 30 °C	Up to 85 °C	Up to 120 °C	Up to 150 °C	Up to 200 °C
DLM-35N-20, 30	5 MPa (50 bar)	2,5 MPa (25 bar)	-	-	-
DLM-35N-21, 22, 31, 40, 41	5 MPa (50 bar)	2,0 MPa (20 bar)	-	-	-
DLM-35N-25	8,0 MPa (80 bar)	6,0 MPa (60 bar)	-	-	-
DLM-35N-50	0,1 MPa (1 bar)	0,1 MPa (1 bar)	-	-	-
DLM-35NT-20, 30	5 MPa (50 bar)	2,5 MPa (25 bar)	1,5 MPa (15 bar)	1 MPa (10 bar)	0,5 MPa (5 bar)
DLM-35NT-21, 22, 31, 40, 41	5 MPa (50 bar)	2,0 MPa (20 bar)	1,5 MPa (15 bar)	1 MPa (10 bar)	0,1 MPa (1 bar)
DLM-35NT-25	8,0 MPa (80 bar)	6,0 MPa (60 bar)	4,0 MPa (40 bar)	3,0 MPa (30 bar)	2,0 MPa (20 bar)
DLM-35NT-50	0,1 MPa (1 bar)	0,1 MPa (1 bar)	0,1 MPa (1 bar)	0,1 MPa (1 bar)	0,1 MPa (1 bar)
DLM-35Xi, XiM-20, 30	5 MPa (50 bar)	2,5 MPa (25 bar)	-	-	-
DLM-35Xi, XiM-21, 22, 31, 40, 41	5 MPa (50 bar)	2,0 MPa (20 bar)	-	-	-
DLM-35Xi, XiM-25	2,0 MPa (20 bar)	2,0 MPa (20 bar)	-	-	-
DLM-35Xi, XiM-50	0,1 MPa (1 bar)	0,1 MPa (1 bar)	-	-	-
DLM-35XiT, XiMT-20, 30	5 MPa (50 bar)	2,5 MPa (25 bar)	1,5 MPa (15 bar)	1 MPa (10 bar)	0,5 MPa (5 bar)
DLM-35XiT, XiMT-21, 22, 31, 40, 41	5 MPa (50 bar)	2,0 MPa (20 bar)	1,5 MPa (15 bar)	1 MPa (10 bar)	0,1 MPa (1 bar)
DLM-35XiT, XiMT-25	2,0 MPa (20 bar)	2,0 MPa (20 bar)	2,0 MPa (20 bar)	2,0 MPa (20 bar)	2,0 MPa (20 bar)
DLM-35XiT, XiMT-50	0,1 MPa (1 bar)	0,1 MPa (1 bar)	0,1 MPa (1 bar)	0,1 MPa (1 bar)	0,1 MPa (1 bar)

# INSTALLATION INSTRUCTIONS

Level meters with coated electrode have protection cover at the end of electrode, which is necessary take down before mounting.

Level meters mount in vertical position to upper lid of tank or reservoir by welding flange, fixing nut or Clamp flange.

For mounting level meter to the metal tank or hopper, it is not necessary to ground the housing again.

In case of installation in concrete sumps or silos, it is appropriate to install the level meter onto a metallic auxiliary construction (console, lid, etc.) and then connect with metal constantly submerged object, eventually with steel armoring.

For level measurement of material in plastic and glass vessels by level meter without reference tube is necessary to connect grounding screw at housing with auxiliary electrode which is fixed in an appropriate manner to the outer casing of vessels (or at the inner wall). Material of auxiliary electrode must be selected with consideration for the working environment and properties of measured material.

## VARIANTS WITH ROD ELECTRODE

DLM-35\_-20, 21, 22, 25, 30, 31

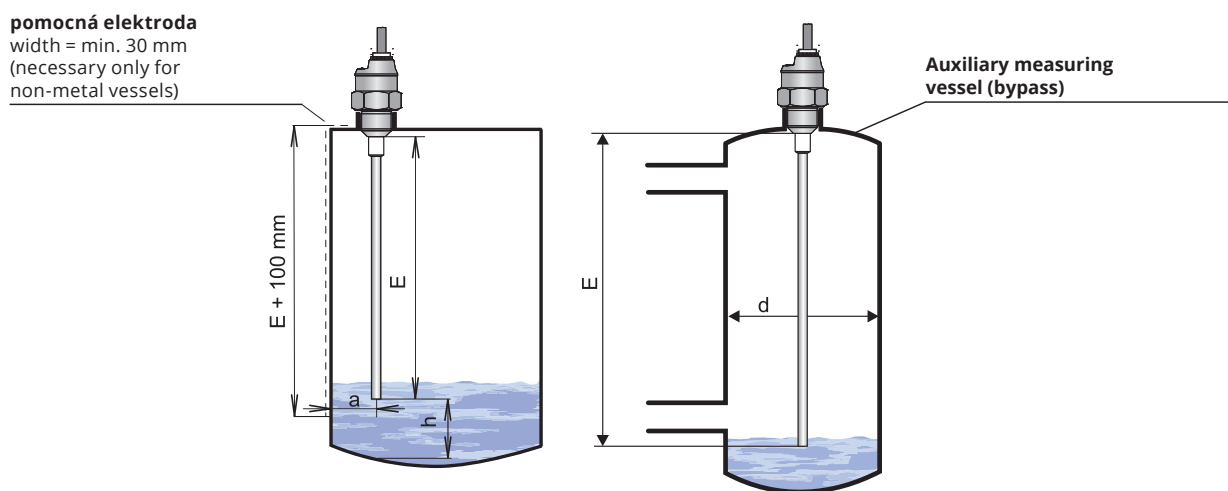

Fig. 19: Installation of level meters with rod electrode

## VARIANTS WITH INSULATED ROPE ELECTRODE

DLM-35\_-52

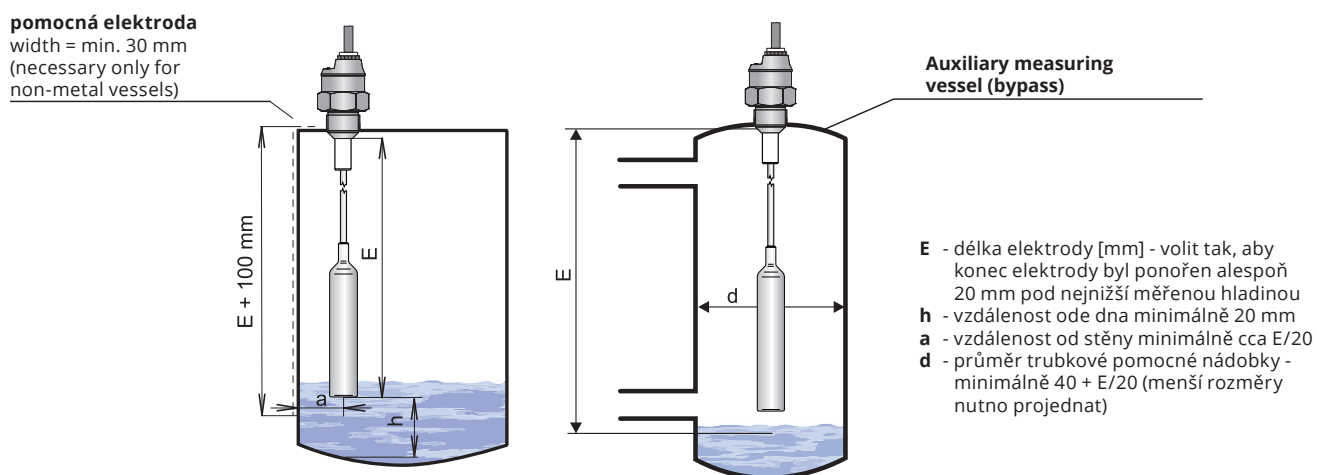
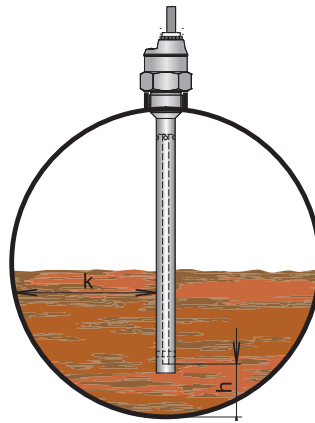

Fig. 20: Installation of level meters with insulated rope electrode



## VARIANTS WITH REFERENCE TUBE

DLM-35\_-40, 41



- h**-the distance from the bottom - min. 20 mm with regard to possibility of the presence of heavier fractions (water) in petroleum products
- k**-the distance from the wall - optional

Fig. 21: Installation of level meter with reference tube

## VARIANTS WITH ROPE ELECTRODE

DLM-35\_-50

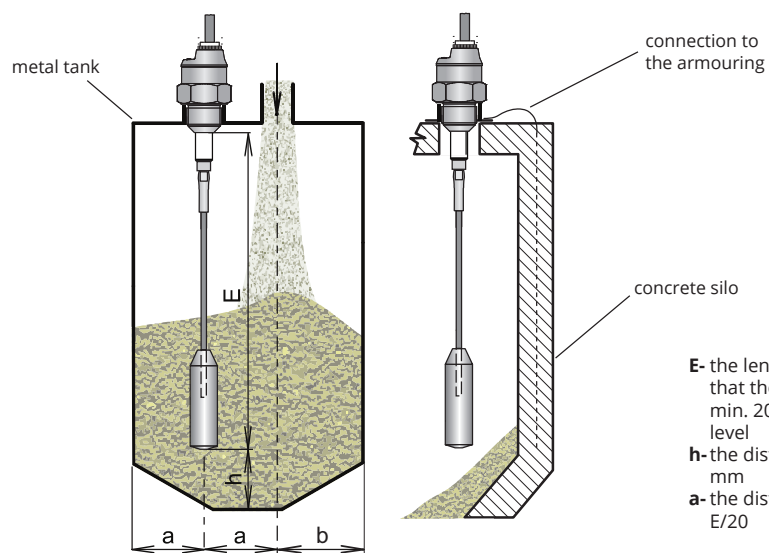

- E**- the length of electrode [mm] - select so that the end of the electrode is dipped min. 20 mm below the lowest measured level
- h**-the distance from the bottom - min. 20 mm
- a**-the distance from the wall - min. approx.  $E/20$

Fig. 22: Installation of level meter with rope electrode

# ELECTRICAL CONNECTION

The positive pole of the supply voltage (+U) is connected to the brown wire BN or pin connector no.1, the negative pole (0 V) is connected to the blue wire BU or pin connector no. 3 and output voltage (U<sub>out</sub>) to the black wire BK or pin connector no. 4.

Wiring diagrams are provided in the figures.

Note: In case of strong ambient electromagnetic interference, paralleling of conductors with power distribution, or for the distribution to distance over 30 m, we recommend using shielded cable.

Level meters DLM-35 with type of cable outlet A, B, V or H are connected to assessing units permanently connected by PVC cable.

Level meters DLM-35 with connection method type C are connected to assessing units by means of a connector socket with compression cable (length 2 or 5 m), or by means of a connector socket without cable (see accessories), the connector is not part of the sensor. In this case the cable is connected to the inside pins of the socket according to figure 6. The recommended diameter of this cable is 4 to 6 mm (the recommended cross-sectional area is 0.25 to 0.5 mm<sup>2</sup>).

The length of the cable for the Xi, XiT, XiM, XiMT variations must be selected with respect to the maximum permitted parameters (usually inductance and capacity) of the outside intrinsically safe circuit of supply units IRU-420.

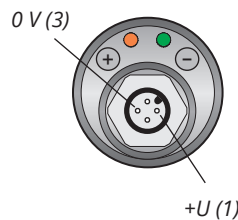
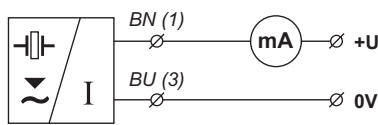

Fig. 23: Connection diagrams and interior view of connector of level meter DLM (variant - I)

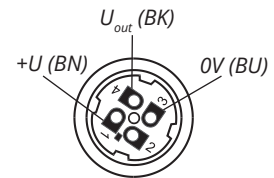

Fig. 24: Inside of the connector socket (variant "C")

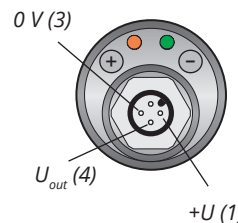
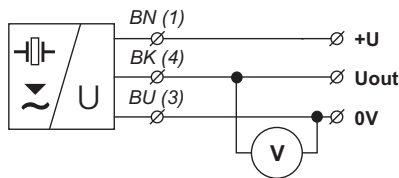

Fig. 25: Connection diagrams and interior view of connector of level meter DLM (variant - U)

**Legend:**  
 (1...) - terminal numbers  
 connector sockets  
 BN - brown  
 BU - blue  
 BK - black



**Electrical connection can only be made when de-energized!**

The source of the power voltage must comprise of a stabilised safe low power source with galvanic separation. In the event that a switchmode power supply is used, it is essential that its construction effectively suppresses common mode interference on the secondary side. In the event that the switch-mode power supply is equipped with a PE safety terminal, it must be unconditionally grounded! Spark-safe devices type DLM-35Xi (XiT, XiM, XiMT) must be powered from a spark-safe power source meeting the above-mentioned requirements.



Due to the possible occurrence of an electrostatic charge on the non-conductive parts of the sensor, it is necessary to ground all sensors intended for use in environments with an explosion hazard DLM-35Xi (XiT, XiM, XiMT). This can be performed by grounding el. conductive tanks or el. conductive tank lids, and in the case of el. non-conductive tanks using and grounding an auxiliary plate electrode PDE-27.

In the event that the level meter is installed in an outdoor environment at a distance greater than 20 m from the outdoor switchboard, or from an enclosed building, it is necessary to supplement the electrical cable leading to the level meter with suitable overvoltage protection.

In the event of strong ambient electromagnetic interference, paralleling of conductors with power distribution, or for distribution to distances over 30 m, we recommend using a shielded cable and grounding the shielding on the side of the power source.

# SETTINGS

Settings of the measuring range are done by touching a magnetic pen to the pair of sensitive spot "-" and "+". Sensitive spot "-" used for input to the setting mode for setting the limit 4 mA (0 V) and decreasing the set current (voltage). Upon reaching the required current (voltage) waits for a permanently illuminated orange LED, and by applying the magnetic pen to the sensitive area "-", confirmation is performed of the set value. Sensitive area "+" is used for input to the setting mode for setting the limit setting 20 mA (10 V) and increasing the set current (voltage). Upon reaching the required current (voltage) it waits for a permanently illuminated orange LED, and by applying the magnetic pen to the sensitive area "+" confirmation is performed of the set value. The setting process is indicated by the orange LED "STATE". The green LED indicator "RUN" indicates correct function of level measurement. You can find more information in the instruction manual.

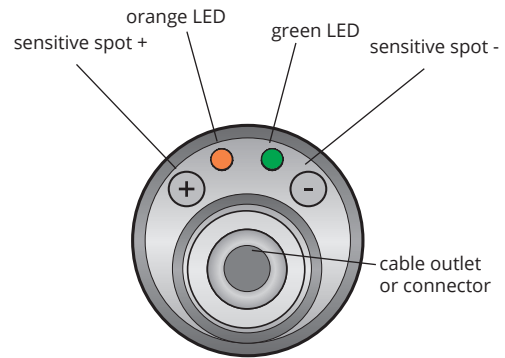

Fig. 26: Top view of level meter

# FUNCTION AND STATUS INDICATION

LED indicator	colour	function
"RUN"	green	<p><b>Measuring function indicator</b></p> <p><b>flashing</b> – correct function of measuring the level (repeats according to period of measuring approx. 0.5 s)</p> <p><b>dark</b> – incorrect installation or malfunction. LED is also not illuminated in limit setting mode.</p> <p><b>alternating flashing green and orange LED</b> – incorrectly set limits</p>
"STATE"	orange	<p><b>Settings indication</b></p> <p><b>slow flashing</b> – indication of setting the lower limit</p> <p><b>rapid flashing</b> – indication of setting the upper limit</p> <p><b>permanent shine</b> – the level meter is prepared to confirm the limit setting by means of mag. pen</p> <p><b>3x short flashes</b> – setting confirmation</p> <p><b>simultaneous shine of green and orange LED</b> – during touching the mag. pen, when the limit setting is confirmed</p>

# ORDER CODE AND CORRECT SPECIFICATION EXAMPLE

## ORDER CODE

DLM-35

### PERFORMANCE

<b>N</b>	non-explosive areas, except output R
<b>NT</b>	high temperature performance, except output R
<b>Xi</b>	☉ for explosive environments, only with output R
<b>XiM</b>	☉ for mining environments, only with output R
<b>XiT</b>	☉ high-temperature conf. for explosive environments, only with output R
<b>XiMT</b>	☉ high-temperature conf. for mining environments, only with output R

### ELECTRODE TYPE

<b>20</b>	rod, uncoated, length 0.1 ... 2 m
<b>21</b>	rod, coated (FEP), length 0.1 ... 2 m
<b>22</b>	rod, coated (PFA), length 0.1 ... 2 m
<b>25</b>	like 21, but higher pressure and mechanical resistance at high temperatures NT variant is only available for Tri-clamp
<b>30</b>	rod, uncoated, length 0.1 ... 3 m
<b>31</b>	rod, coated (FEP), length 0.1 ... 3 m
<b>40</b>	rod, uncoated with ref. tube, length 0.1 ... 1 m, except process connection CI34 a CI50
<b>41</b>	rod, coated (FEP) with ref. tube, length 0.1 ... 1 m, except process connection CI34 a CI50
<b>50</b>	rope with weight, uncoated, length 1 ... 6 m, except process connection CI34 a CI50
<b>52</b>	coated rope weighted electrode (FEP), length 1 ... 10 m

### PROCESS CONNECTION

<b>G1</b>	pipe thread závit G 1"
<b>G3/4</b>	pipe thread G 3/4"
<b>M27</b>	metric thread M 27x2
<b>M30</b>	metric thread M 30x1,5
<b>NPT</b>	pressure thread NPT 3/4
<b>CI34</b>	Tri-clamp (ø 34 mm), except electrode type 40, 41, 50
<b>CI50</b>	Tri-clamp (ø 50,5 mm), except electrode type 40, 41, 50

### OUTPUT TYPE

<b>I</b>	current (4 ... 30 mA)
<b>U</b>	voltage (0 ... 10 V)

### CONNECTION METHOD

<b>A</b>	short stainless steel gland
<b>B</b>	plastic threaded cable gland
<b>C</b>	connector (socket not included with sensor, recommended type)
<b>D</b>	metal dust proof terminal
<b>V</b>	plastic cable gland with spiral
<b>H</b>	plastic cable gland for protective hose

### ELECTRODE

<b>E</b>	length in mm
----------	--------------

### CABLE

<b>K</b>	length in m
----------	-------------

DLM-35 N - 20 - G1 - N - A E50 K5 EXAMPLE OF CODING

# ACCESSORIES

1x magnetic pen	included in the price	MP-8	
1x seal (asbestos free) *	included in the price		
cable (over the standard length 2m)	at extra cost	PVC 3 × 0,5 PVC 2 × 0,75 blue	
connector socket	at extra cost	ELWIKA, ELKA	
normal steel welding flange or stainless steel welding flange	at extra cost	ON-__ NN-__	
protective hose (for type of cable outlet H)	at extra cost	OH-10	
stainless steel fixing nut	at extra cost	UM-__	
various types of seals (PTFE, Al, etc.)	at extra cost		
auxiliary plate electrode	at extra cost	PDE-27	

\* Pressure resistance - see the table in the accessories datasheet in the „seals and gaskets“.

# SAFETY, PROTECTIONS, COMPATIBILITY AND EXPLOSION PROOF

The level sensor is equipped with protection against electric shock on the electrode, reverse polarity, output current overload, short circuit and against current overload on output.

Protection against dangerous contact is provided by low safety voltage according to EN 33 2000- 4- 41. Electromagnetic compatibility is provided by conformity with standards EN 55022 / B, EN 61326-1, EN 61000-4-2 to -8.

Explosion proof DLM-35Xi (XiT, XiM, XiMT) is provided by conformity with standards EN 60079-0, EN 60079-11, EN 60079-26.

Explosion proof DLM-35Xi (XiT, XiM, XiMT) is verified FTZÚ – AO 210 Ostrava – Radvanice: FTZÚ 16 ATEX 0140X.

A declaration of conformity was issued for this device in the wording of Act No. 90/2016 Coll., as amended. Supplied electrical equipment matches the requirements of valid European directives for safety and electromagnetic compatibility.

## SPECIAL CONDITIONS FOR SAFE USE OF VARIANT DLM-35XI (XiT, XiM, XiMT)

Level meters DLM-35Xi(XiT, XiM, XiMT) are intended for connection to approved spark-safe power supply unit circuits (of insulating transducers) with galvanic separation. In the event that devices without galvanic separation are used (Zener barriers), it is necessary to balance the potential between the sensor, resp. level meter and the barrier grounding location.

The limit output parameters of spark-safe units (insulating transducers) must correspond to the limit input parameters of the level meter. When assessing spark-free safety of circuits, it is necessary to also take into consideration the parameters of the connected cable (namely its induction and capacity).

The DLM-35Xi configuration may be located in zone 0 or zone 20. With the DLM-35XiT configuration it is only possible to locate the electrode part in zone 0 and in zone 20, and then the head with the electronics in zone 1 or zone 21.

Ambient temperature:  $T_{amb} = -40^{\circ}\text{C}$  to  $+75^{\circ}\text{C}$ .

The temperature of the measured material according to the variant configuration, see chapter „Technical parameters“. The maximum temperature of the electrodes equals the temperature of the measured material.

Variant DLM-35XiMT it is necessary to observe that temperature of any surface of apparatus, when coal dust can from a layer, do not exceed  $150^{\circ}\text{C}$ .

### Version Xi:

Temperature classes for EPL Ga:

T2 ... applies to the maximum temperature of the medium  
 $T_m = 270^{\circ}\text{C}$ .

T3 ... applies to the maximum medium temperature  
 $T_m = 180^{\circ}\text{C}$ .

T4 ... applies to the maximum medium temperature  
 $T_m = 115^{\circ}\text{C}$ .

Maximum surface temperature for EPL Da:

The temperature range of the medium is  $-40^{\circ}\text{C}$  to  $300^{\circ}\text{C}$ .

The maximum surface temperature must be calculated as  
 $T_{200} = T_m + 45^{\circ}\text{C}$ .

### Version XiT

Temperature classes for EPL Ga/Gb:

T2 ... applies to the maximum temperature of the medium  
 $T_m = 270^{\circ}\text{C}$ .

T3 ... applies to the maximum medium temperature  
 $T_m = 180^{\circ}\text{C}$ .

T4 ... applies to the maximum medium temperature  
 $T_m = 115^{\circ}\text{C}$ .

Maximum surface temperature for EPL Da/Db:

The temperature range of the medium is  $-40^{\circ}\text{C}$  to  $300^{\circ}\text{C}$ .

The maximum surface temperature for the part of the EPL product must be calculated as  $T_{200} = T_m + 45^{\circ}\text{C}$ .

### Version XiM, XiMT

The maximum temperature of the medium is  $145^{\circ}\text{C}$ .

For explosive dust atmospheres, the equipment must be installed in such a way as to avoid the risk of creeping discharges on the label, cable gland or connector of the equipment.

*The manufacturer reserves the right to change specifications and appearance of the product without prior notice.*

**Dinel, s.r.o.**

U Tescomy 249, 760 01 Zlín

tel.: +420 577 002 000

e-mail: sale@dinel.cz

[www.dinel.cz](http://www.dinel.cz)

version:  
07/2022

